

REF. 1938

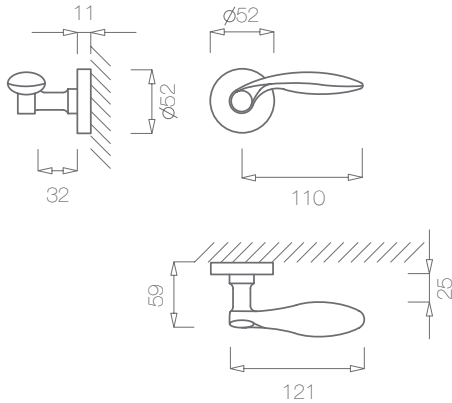

(01)

latão polido brilhante
polished brass



(03)

cromado brilhante
bright chrome



(77)

bronzado mate
mate antique brass

Descrição

Puxador par
Adaptador com sistema "click"
Mola recuperadora
Ferro quadrado de 8x90mm
Fixação da muleta com perno M6 oculto

Description

Lever set
Mechanism with "click" system
Recovery spring
8x90mm square spindle
Handle fixed by a M6 grub screw

Matéria Prima

Latão CW617N

Raw Material

Brass CW617N

Aplicação

Portas interiores com 30mm - 45mm espessura

Application

Interior doors with 30mm - 45mm thick

EN 1906

2	7	-	0	0	4	0	B
---	---	---	---	---	---	---	---

(acabamentos / finishes 01 - 03)