

REF. 4140 RE

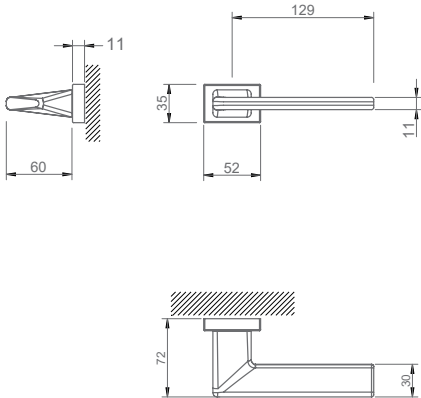

Descrição

Puxador par
Mola recuperadora
Ferro quadrado de 8x90mm
Fixação da muleta com perno M6 oculto

Description

Lever set
Recovery spring
8x90mm square spindle
Handle fixed by a M6 grub screw

Matéria Prima

Zamak ZnAl4Cu1 / EN1774

Raw Material

Zamak ZnAl4Cu1 / EN1774

EN 1906

2	7	-	0	0	4	0	B
---	---	---	---	---	---	---	---

(acabamentos / finishes 152 - 153)

3	7	-	0	0	4	0	B
---	---	---	---	---	---	---	---

(acabamentos / finishes 96)

2	7	-	0	0	3	0	B
---	---	---	---	---	---	---	---

(acabamentos / finishes 141 - 142)