

REF. 4200/201 5S

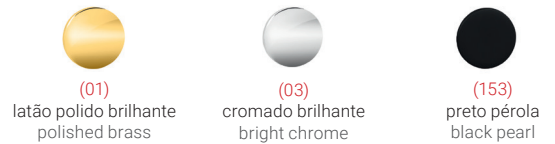
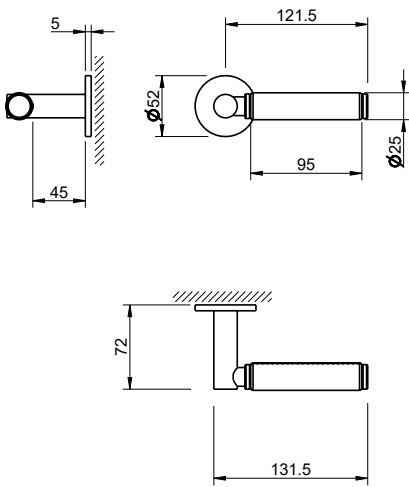

Descrição

Puxador par
Adaptador metálico com sistema "click"
Mola recuperadora reversível
Ferro quadrado de 8x90mm
Fixação da muleta com perno M6 oculto

Description

Lever set
Metallic mechanism with "click" system
Reversible recovery spring
8x90mm square spindle
Handle fixed by a M6 grub screw

Matéria Prima

Latão CW617N

Raw Material

Brass CW617N

Aplicação

Portas interiores com 30mm - 45mm espessura

Application

Interior doors with 30mm - 45mm thick

EN 1906

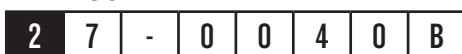

(acabamentos / finishes 01 - 03 - 153)